



MVCC NEWS

**“KEEPING EM ROLLING, FLOATING
AND FLYING FOR 39 YEARS”**

ISSUE #11 2016

COURAGE

VETERANS DAY
NOVEMBER 11, 2016
HONORING ALL WHO SERVED

www.va.gov



CONTENTS

UPCOMING EVENTS	4
MVCC STAFF	3, 5, 8,
CLASSIFIEDS	16, 17
MVCC MEMBERSHIP APPLICATION	22

FROM THE SECRETARY

To MVCC Members:

Online memberships-

It had been brought to attention that some members do not know how to get their online membership newsletters. Below you will find how to get access to them. If you did not pay for the online membership then there is no need to worry, yours will come in the mail.

The positives of getting an online membership is that the newsletters are delivered online instantly and IN COLOR!

If you paid for the online newsletter membership, you must contact MVCC's webmaster Sean Nichols at jetnoise400@hotmail.com or (775)424-3813 to get your password. He will have your information or you can contact me to find out your membership status. Sean will set you up with your own password so you can log online at www.mvccnews.net, and there you can view all MVCC Newsletters online and IN COLOR! Should your membership expire Sean will stop your access.

If you have any questions or concerns please email me at istanbull@sbcglobal.net, and I will see what I can do for you.

Name tags-

If you are a paid member and do not have a name tag and would like to purchase one, they are \$9 at the moment. The price changes, so if it's less we will pass on the savings to our members. If you need a replacement badge you may order one as well at the same price.

The new badges look a little different from the old ones, so it doesn't hurt to have an extra badge. Membership dues are due January 1, 2017 unless you are paid until 2018 or later. There are many that choose to do the 3 year membership which has saved them some money.

Sincerely,

John Verissimo

MVCC Secretary

Istanbul@sbcglobal.net

(209)918-0488

AT THE FRONT



Dave Ball, MVCC President
(408) 805-0065
vought@msn.com

Hi Everyone...

Well its raining again, and Thanksgiving is about ten days away. I hope everyone gets to spend sometime with family and friends and fill up on some traditional vittles. This is that time of year when we mothball our old iron and replace worn out or misbehaving parts with those we have collected during the swapmeet season for off season repairs. A word to the wise, Petaluma is coming and there are many opportunities for driving our military vehicles on roads without the demand for rocket assist. I hope to get my M-170 finished in time for it. Speaking of Petaluma, I have written a short article on what to expect at our new location for the 40th Annual Spring MVCC Swapmeet. It is in this issue.

I am getting some calls from members who have gone and visited Petaluma KOA who want to voice some concerns with the venue change. Several members wanted to point out the coastal climate and the lack of parking space.

Yes, it might rain in Petaluma. It could also be really nice in the 70s and sunny everyday. Parking will be just like at Tower Park. We will, with everyone's cooperation, make it work. We will probably park our car trailers offsite. There is a huge parking area just below the park's office building, but it has a pretty high water table due to the Petaluma River being nearby or actually under it. It does get muddy and/or have standing water issues during high tides or after several days of rain. Guess it's a good thing we collect military vehicles, and we don't mind a little mud on our tires or tracks. Most of us after years of rainouts at Patterson, Big Bear, and Tower Park know in April you should prepare for rain, so we travel well equipped and are used to some weather related tarp spreading and adult beverage breaks. Just remember to put the tarps in the trailer before you leave and hook up the fording pipes. Don't forget the beverages. It's that time of year where you start seeing Uncle Sam on the cover of the newsletter saying to pay your dues now! We know you won't forget, but just a friendly reminder before you blow all your dough on black Friday military ponchos, tarps and fording gear that you probably won't need but should always carry. The newsletter cut off date for non-paying members will be February 28, 2017.

I want to wish everyone a great Thanksgiving,
Dave Ball

MVCC FRONT OFFICE

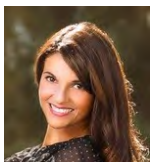

Christina Verissimo, Treasurer
(209) 918-0388
crstna_vrsmo@yahoo.com



John Verissimo, Secretary
(209) 918-0488
istanbull@sbcglobal.net



Quartermaster, Position Vacant

SPRING SWAPMEET NEWS

PETALUMA HERE WE COME

Listed below is some useful info about the April 18-23, 2017, Swap Meet move to Petaluma KOA. I will try and answer some questions and give you some useful info in this short article.

As you probably already know, Tower Park was sold to Jellystone Park Camp-Resort, and because of the changes Jellystone has planned for that park, we are moving the Swap Meet in April 2017, to Petaluma KOA. An exhaustive search was conducted for a new park that would meet the various needs of MVCC members. Petaluma KOA had many of the attributes we have enjoyed at Tower Park plus a couple added benefits. This is an MVCC Swap Meet and is open to all. MVCC members get first choice of campsites. Guests and visitors are welcome. There is a four night minimum stay. This was instituted during negotiations with KOA to bring down the rates and to help secure the campground, so that the MVCC would have exclusive use for as many days as possible. The four nights will be anytime Tuesday thru Saturday. You will still be able to come in early and stay later if you would like to. Also KOA has promised not to double rent a paid spot if a camper pulls out early.

JoAnn lesser is acting as our Wagon Master and all reservations and cancelations need to be made and tracked by Joann. She is the MVCC's primary contact with KOA. Joann's phone number is 408-238-8277.

Joann is working very hard at this time to accommodate everyone who would have had a reservation for the 2017 Spring Swap Meet at Tower Park. You cannot get a campsite for our event by calling KOA or going to their website.

As of today, you can call Petaluma KOA and pay to reserve your site. Joann has sent a list to KOA with all the reserved site info, and it has been put into the KOA reservation system. It is now up to you the member to get a deposit on your site by calling the KOA in Petaluma. If you are not in their system, please call Joann. The phone number for Petaluma KOA is 707-763-1492. The address is 20 Rainsville Road, Petaluma CA. 94952. The official dates for the MVCC Spring Swap Meet are April 18-23, 2017. The KOA website is <http://koa.com/campgrounds/san-francisco/>

There are various types of campsites and costs for them ranging from 65 foot long full pull throughs at \$50 a night for single use and \$37.50 a night for double use. Also developed sites that are tent or vehicle dry camping for \$37.50 a night as well as dry tent only camping in three group areas at \$10 a head a night. The 6 person Deluxe Lodges are \$140 a night and the studio lodges are \$130 a night. There are a number of 1 room camping cabins without bathrooms that are \$57 a night. These have a TV and low wattage power. Take notice that if you share a pull through, you can put two small motor homes or a motor home and a tent and share the hookups for \$37.50 a night each. The park has a truck to service your dump tanks at your campsite if you are in a site that has water and power but no sewer. They will pump your tanks twice during the week for free. You do not have to be there. They will give you two stickers for your windshield. Make sure to ask for them when you check in. There is onsite propane and a dump station.

Down in the tent camping area, there is a camp kitchen with sinks and counters to wash dishes and prepare food. There are freshly remodeled restrooms with showers throughout the park. Amenities include a large pool, hot tub, and store in the office with firewood for the fire pits in the campsites. When you check-in you will be given a wristband for everyone in your party present up to four depending on your site type of course. If you have guests arriving later, they can pick theirs up when they check-in at the KOA desk. Everyone must check in and wear their wristband. If you tow a vehicle on a trailer, we are working on nearby parking for trailers so stayed tuned for that info.

Sonoma county and the north coast is an area that has many outdoor activities. There are many lazy roads to travel to local attractions that are either day or half-day trips. Some attractions are a mile away in downtown Petaluma, and some are 20 miles away at the coast or nearby wine country. As we get closer, there will be more info about food during the day, dinners and activities.

**So stayed tuned,
Dave Ball**

UPCOMING EVENTS

April 18-23 2017 Spring Meet Petaluma KOA.

No vendor fee except camping fee.

Contact: MVCC Wagon Master Jo-Ann Lesser;
(408) 238- 8277 mamalesser@yahoo.com



Don Gomes, Central Valley VP
Divisions 209,559,661,760
(209)765-1273
caddymanwestside@yahoo.com

March 19, 2017 San Jose Militaria show and sale.
Naperdak Hall 770 Montague expwy. San Jose.
9am to 3pm \$7.00 admission or \$15.00 admission at
7:30am for earlybird.

Contact: Military Annex 408-275-9730 Pete
Email: militaryannex@yahoo.com



Scott Rohrs, North. Bay West VP
Divisions 707 & 415 west
415-259-8177
recon3rdid@yahoo.com

September 20-25, 2016 Fall Meet

Second largest annual MV gathering and swap meet
in the West. Location TBD



Jack Valenti, Central Coast VP
Divisions 831, 805 408 south
LRDG@PRODIGY.NET
831-595-3487

October 2017: CAMP GRIDLEY at the Butte
County Fairgrounds, 199 E. Hazel St. Gridley, Cali-
fornia. Hosted by the NORTHERN RECON
GROUP.: www.northernrecongroup.org or contact:
Bill Campbell (530) 518-1353,
nrg-news@comcast.net



Kim Sievert, South Bay VP
(408) 253-9469
vaudevillian@msn.com
Divisions 408, 669 North 650

If you have any questions or have information regarding a meet or activity in your area, contact your regional vice president or any of the officers to let them know. Be sure to visit our website for any last minute activities or changes to activities/events. Please submit information regarding upcoming activities to the newsletter editor at least two months before the scheduled event. All articles must be submitted to the newsletter editor by the 15th of each month.
MVCC News Editor Dave Ball vought@msn.com www.mvccnews.net



MVCC NEWS STAFF



MVCC Editor Dave Ball

(408) 805-0065 vought@msn.com

Please submit all contributions for publication in
the newsletter by email to the editor by the 15 of
the month.



Webmaster Sean Nichols
Jetnoise400@hotmail.com
www.mvccnews.net
(775)-424-3813

CALL 800-600-JEEP (5337)

Ron Fitzpatrick

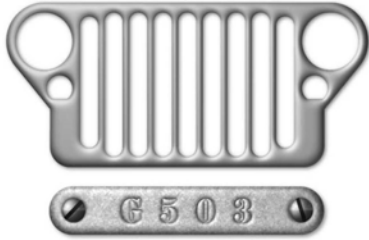

JEEP PARTS

SEE OUR WEBSITE @ www.G503.com/parts



(541) 830-3030 (local) * (541) 830-3031 (tech)
sales@g503.com (541) 830-5337 (fax)
M-F 8 a.m. till 5 p.m. West Coast

SECURE ONLINE ORDERING @ www.rfjp.com



A2885 & A2893
Doorway Strap Cast Bracket
Complete Assy \$12.50
(*F* Marked Available)



Front
Gussets
\$15 Ea

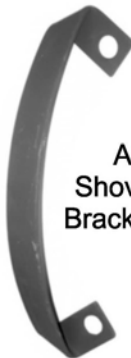

A3082
Shovel Front
Bracket \$12.50



A2995
Axe Clamp
Front Bracket \$7.50
(*F* Marked Available)



MB
or
GPW "F" marked



A2984
Axe Clamp
Rear Bracket \$12.50
(*F* Marked Available)



A2984-E
Early Axe Clamp
Rear Bracket \$12.50
(*F* Marked Available)



A3197
Latch Hood
To Windshield \$3



A2896
Latch Fender
To Hood \$2.50



A6393
Pintle Hook
Eye Bolt \$17.50

A693
Early Fire Extinguisher
Bracket \$35



Shipping & Order Policy

No Handling or Box fee ~ No charge for HAZMAT fee ~ No Minimum Order ~ We ship all in-stock parts same day if order is placed before 2:00 PM PST M-F ~ Prices subject to change ~ Minimum shipping charge \$2.00 ~ Actual Shipping or Freight charges only)

MVCC BUSINESS MEMBERS

Ron Fitzpatrick
JEEP PARTS



1022 Newland Road
 Central Point, Oregon 97502

sales: 800-600-5337
 tech: 541-830-3030
 fax: 541-830-5337

www.rfjp.com www.g503.com/parts

RON FITZPATRICK
 sales@g503.com
 ron@g503.com



Dc Truck parts 541-772-8992

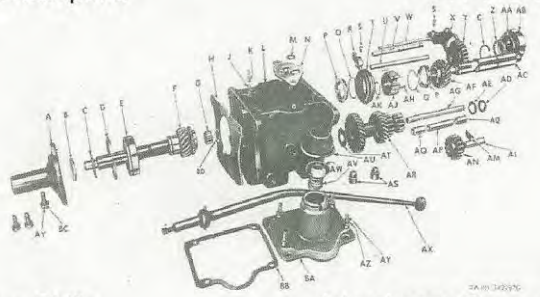

Dave Cirillo
 dctruckparts@msn.com

EXPEDITION IMPORTS
Get Out of the Ordinary!

Scott Ingham
 President

scott@expedition-imports.com
 www.mpttires.com
 www.expedition-imports.com

1335 Lemon Street
 Vallejo, CA 94590
 Tel 707.643.6757
 Cell 707.319.7252
 Fax 707.643.2998

Ray Del Pino  DMV License #VV17807

ANTIQUE • CLASSIC • MODERN
 VIN NUMBER VERIFICATION
 AT YOUR LOCATION IN SOUTHERN CA
 TRUCKS, TRAILERS, SPECIAL MOBILE EQUIPMENT
 MOTOR HOMES, AND CARS
 DMV RUNNER SERVICE
 CLASS C DRIVEAWAY - GETAWAY DRIVER
 15708 E. Grovescenter St. • Covina, CA 91722
 Cell: (626) 391-2167 • Home: (626) 814-2196



DOWNTOWN TRUCK PARTS

NORMAN GORELICK

20830 KINGSBURY ST
 CHATSWORTH CA 91311

1-818-709-3676
 MACK6X6@AOL.COM



CARSON PLAINS SURPLUS & STORAGE
 Military Surplus, Military Vehicles, Storage, Firewood
JON BIRCHEFF
 Owner



P.O. Box 1289
 70 S. Rainbow Dr
 Dayton, NV 89403
 Cell: 775-246-7186
 Fax: 775-241-7142
 jon.cpsands@gmail.com
 www.cpsands.com

JAY'S WWII JEEPS

Specializing in vintage WWII Willys MB/Ford GPW vehicles and parts

1-844-WW2-JEEP



Jay Hinton | Napa, California USA | 1-844-992-5337 | jay@jaysww2jeeps.com

MVCC STAFF



Sonny Hanson, No. Bay, East VP
(707) 552-6918 Div. 707,415
sonnyhanson@comcast.net

Hello to everyone in the North Bay. It's Friday 11-14-16 and it's raining. That tells me I need to start work on my winter maintenance and repairs. All my six trucks are running but there are a few little things to fix. Like leaking seals, disappearing break fluid, (I don't know where the fluid is going) put on new tires, touch up paint, etc. In the Sept. newsletter, I told you I found some LED lights for my 41 Dodge. They fit right into the stock tail light and look just like the stock ones only brighter. I forgot to say that I got them from Paul Fitzgerald in Hercules CA. 94547. He makes them in his workshop at home. If you are interested, you can call him at 925-595-1236. He is an MVCC member and has several MV's.
Have a happy and safe Thanksgiving.

Sonny Hanson
Your MVCC North Bay VP east
Working hard for you
From my non-mobile command center



US Navy Seabees with their well taken care of and nicely decorated GMC CCKW Dump Truck. Picture looks to have been taken on Island X on a Marston Mat / PSP fighter strip. I believe this is a repaired or poorly scanned war time magazine picture.

USN

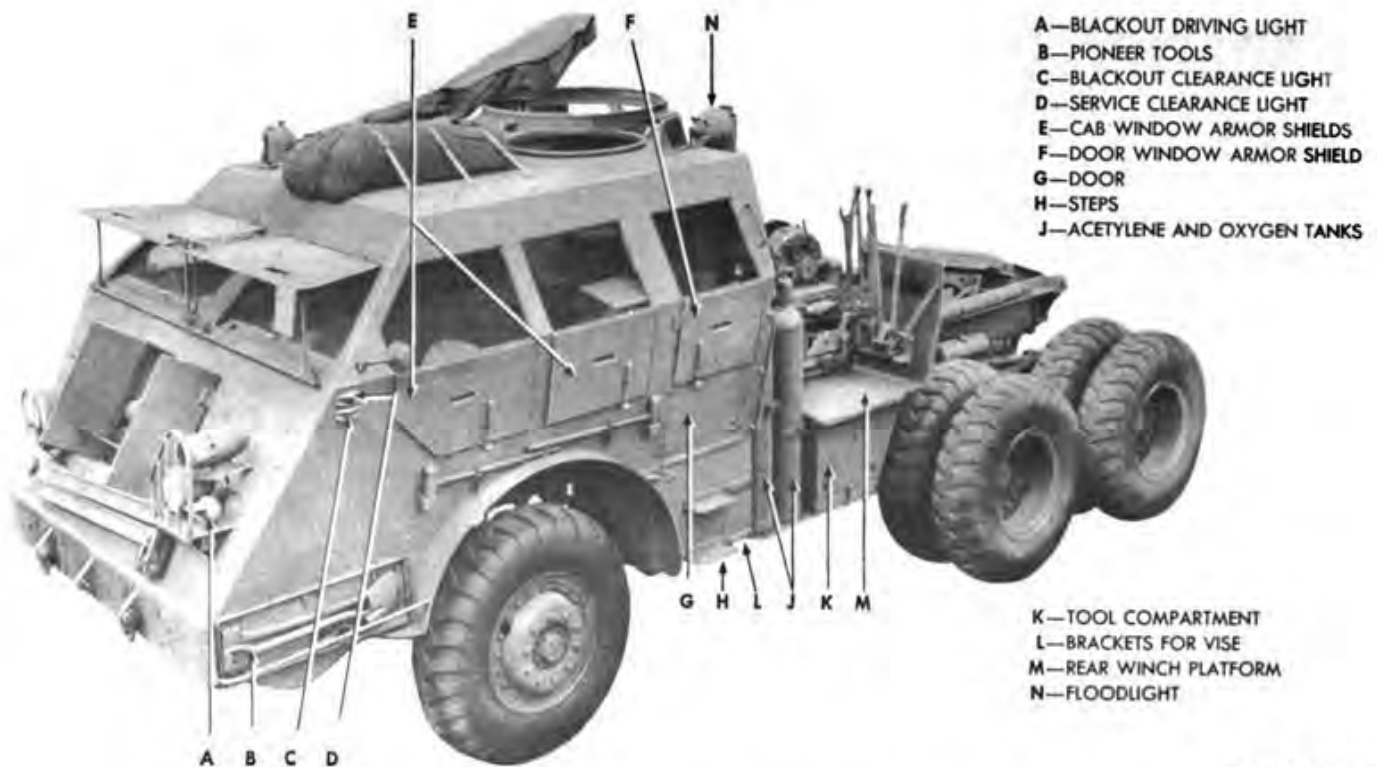

RA PD 48202

Figure 3—Left Front Three-quarter View of Tractor Truck M26 (Windows Open)

Above is the Knuckey Prototype. The Knuckey Truck Company of San Francisco, in response to a War Department request, designed a heavy tank transporter, Named the M-26, in 1943. Weight 22 tons. Unfortunately Knuckey had limited floor space. And the contract was awarded to Pacific Car and Foundry. Below the production M26A1 armored version known as the Dragon Wagon built by Pacific Car and Foundry of Renton, Washington. It used the proprietary Knuckey Chain drive rear axles. Ed.





Pictures from the 2016 Los Banos Veterans day Parade. The picture at the top on page 10 from Left to right Jim Bertao, Jess Soriano, Ralph Hunter, Mark Jones, Chris Thomas, Paul Lubker, Christina and John Verissimo, Up top Don Gomes, Mark Orozco and Jordan Gomes. John Verissimo



East Bay VP Mike Rinehart
 Divisions 510, 925 510-522-6440
 michaelwrinehart@sbcglobal.net

To all:

These pics were taken at the end of the Pleasanton Veterans parade 2016. I am taking the shot. I want to thank everyone that made the convoy and parade. We had to take a different route into Pleasanton and had a lot of signals to go through. With the radios on and timing we did not get broken up. (Thanks to Randy Parent and Ed Schommer and their radio equipped Mutt's.) My left cheek from the clutch and the Dodge's gear box have not recovered yet. LOL. Thanks for a great season. Debbie and I wish you all a great Thanksgiving and Holiday season.
 Mike



**SUPPORT YOUR LOCAL
 WAR BIRDS**

**WANTED WWII
 AIRCRAFT AND VEHICLES**

**MARC MCCASLIN
 661-204-4487**

**CHOPPED47FORD@AOL.COM
 VULTEEKIN@YAHOO.COM**

**Smith Chevrolet
 Cadillac, Inc.**

*"Where service comes
 first since 1926"*

**1601 Auto Mall Drive
 Turlock, CA 95380**

**Lee C. Smith
 Owner**

(209) 632-3946
 (209) 988-8832 Cell
 (209) 667-7157 Fax
 leesmith@SmithChevroletCadillac.com

smithchevroletcadillac.com

find us on facebook



Dave Porter, Northern Region VP
Divisions 530 & 916
dnporter56@comcast.net
530-677-5115

Hello from the North,

We attended three events for Veterans Day: On November 10th, a presentation and display at the El Dorado Hills Senior Center featuring Nancy Porter giving a talk on WWII sites you can visit in Hawaii, Vanuatu, Solomon Islands, and other islands in the South Pacific. I displayed a '43 GTB cargo truck and my '45 Willys Holden style ambulance jeep, both appropriately USMC vehicles for the Marine Corps birthday that day. The vehicles drew a large crowd including a couple of appreciative Marine Corps vets. On November 11th, the annual Veterans Day Parade in Auburn. We had 10 jeeps and a Halftrack in attendance, organized by Ben Hovis and the Foothill Vintage Jeep Group. I transported Barney Gruber, a locally popular Marine Corps vet that fought on Iwo Jima in WWII. On November 12th, a display hosted by the Northern Recon Group included free rides for veterans and veteran's family members on an authentic, operational "Higgins boat" LCVP landing craft, the same one that was on display at the MVPA Convention in Pleasanton. I was able to drive my '43 GPW onto the landing craft and go for a short cruise in Ellis Lake in Marysville, followed by a driving the jeep down the ramp and out onto the shore in a dramatic "landing", splashing through 6" of water onto the boat ramp. What a kick.

Upcoming events are winding down for 2016, with a few Christmas parties to attend being about the only thing left for this year. In early December we'll be flying with a small group of military vehicle collectors to Oahu for the 75th anniversary of the attack on Pearl Harbor. We'll be visiting WWII sites, watching the parade in Honolulu, and going on the last "Home of the Brave" tour. The tour includes visits to the USS Arizona memorial, the USS Missouri, the Museum of the Pacific on Ford Island, Wheeler Field and other sites with an emphasis on December 7, 1941. Watch for pictures and more after we get back home.

Keep 'em Rollin'
Dave



CLASSIFIEDS

FOR SALE

For Sale: MB/GPW original fuel tank. Has gone through the Gas Tank Renu process. \$325 obo
Matt (408)398-0036 or msira36@aol.com 11-16

For Sale: 1952 T90 transmission and transfer case, rebuilt. \$125. Would love to see it in somebody's jeep. 1954 F head engine. Salvaged from wrecked vehicle. Would be a rebuild project. Best offer. Mike 650 678 5284. 12-16

For Sale: Radio set for Jeep or M series Military vehicle. In very good cond. 3 part standard radio set w/ mounting bracket from the Korea era 24 volt. Contact Sieg 510-522-2244 or email northlandskip@hotmail.com Eves best. \$475.00 Can deliver fall Tower Park or u pick-up. Alameda 11-16

For Sale: 4 post car lift for your back yard or garage. Pro rated, 4 post, name Universal lift. Bench Co. Was in a transmission shop working. Can deliver 50 miles from Alameda Ca. will need fork lift or 3-4 strong guys. Call Skip 510-522-2244 or 316-3130 Send me your offers. 1st. \$1,500.00 takes it. On my trailer ready to be delivered. 11-16

For Sale: Dodge 1/2 ton parts: Complete transmission, rear axle shafts, third member 4:89, New Master Cylinder, Wheel cylinders, 16 inch wheels and rings, Steering gear and column, Door parts for closed cab, 6volt horn, Etc.. All reasonably priced.
Tom Lamar: 408-296-7677 12-16

For Sale: 1941 Dodge WC-4 1/2ton. Rough shape but it looks like all the pieces are there. Selling for a friend in Nevada. Can email pictures and put you in contact with owner \$3100
Lee Edwards whenlde@aol.com 925-447-9387.
12-16

FOR SALE

For Sale: 1944 Willys MB Jeep and MBT Trailer. DoD: 7 December 1944 (Historic date!) Restored in 1990s, overhauled in 2014. Only 15 miles since overhaul. This Jeep is complete as would be issued in 1944. 85% original parts. Has original data plates. Runs and drives fine. Zero rust and has always been garaged. Original grease gun, oil can, gas can, tire pump, crank, brass fire extinguisher. Complete with NOS SCR 510/610 Radio, original mount, antennas and all accessories. Original M31C Pedestal Mount, NOS windshield rifle rack, tool kit, 1st Aid Kit with WWII contents, chains, all canvas, spare parts kit, manuals, Jeep books, Exc. ND type tires, Officer Bedrolls, packs, WWII map case, binoculars with case, replica M1919A4 MG (original barrel and barrel jacket) ammo boxes, belt, pintle and more. Trailer is VG condition with all original parts (replica data plate) and WWII water can, gas cans, storage container and more. Only trailer has combat wheels. Ready for display or reenactments. \$18,000. Ken (530) 268-3539, E-Mail: Ken1945@onemain.com 12-16
See picture below



Classified Ads are free for military vehicle related items and kit for MVCC members. Your ad will run for three issues. Your editor will only except ads in writing. Please submit your ad by email: vought@msn.com or by post to: MVCC Editor: 18549 Paseo Tierra St. Saratoga Ca. 95070. Please print clearly and include contact info and price. Please submit ads by the 15th of the month. If you want to make changes to your ad including extending or cancelling your ad, you must notify your editor in writing. The MVCC is not responsible for omission's or Incorrect wording and or spelling. The MVCC reserves the right to edit ad copy for space. Please send payment for paid ads to: LK Viola, Email: sec-treasurer@mvccnews.net

Ad prices: full page \$45 Half page \$35 Quarter Page \$20 Business Card \$5 per issue

CLASSIFIEDS

FOR SALE

For Sale: International parts from M-2-4 Take out Bed and Cab. Misc. M-3-4 and M-5H-6. Call or email Dave with your needs 408-805-0065 vought@msn.com

For Sale: 1968 Kaiser M715 Has had a Chevy V8 installed using Novak's kit. Also duel pot Master Cylinder. Has hardtop. Original paint and markings from 725 25 MT group in Hawaii Truck is rot free, runs and stops. Registered and insured. \$5500 obo. Call Dave 408-805-0065 for more info

For Sale: 1942 Chevy G506 cargo truck running gear all original and runs great . All original gauges, new canvas seat cover ,upgraded brake booster , black out marker lights ,front windshield, 12 circuit wire harness. Also have 1942 cargo bed needs some bodywork. Sold with bill of sale only \$7500 OBO. 209-765-1273 Ask for Don picture below caddymanwestside@yahoo.com



For Sale: 1951 M38 Jeep, Excellent Condition, Older Restoration, located in Patterson, Ca. Original Data Plates, Beachwood Canvas Top, windshield cover and seats, NOS radiator. Have all the receipts of restoration. Engine, transmission and transfer case rebuilt. Ready for Parades and driving around town. Registered in Ca. Clean Title. Reproduction tub. Asking \$12,500 obo. For more information contact Paul Lubker, (209)403-6261 See picture top left page 11 this issue

WANTED ITEMS

Wanted: Dodge brake drums, Budd, part number 45406. These brake drums fit 3/4 ton Dodge WC, Flat fender Power Wagon and Dodge M37. 14.185 Max I.D.. Tom Lamar 408-296-7677 12-16

Wanted: For WWII WC51/52, or vehicles that interchange. Need inner and/or outer Windshield Frames, Tailgate and hinges, one Hood Latch. Also need the Bed Wood, one or two good pieces so I can make new ones. Or the Plans for making new ones if you happen to have them. Also need the steel bed strips. Matt (408) 398-0036 or msira36@aol.com 11-16

Wanted: Front axle suspension, covered springs for WC Dodge 1/2 ton ambulance. The springs are covered with sheet metal. Call or e-mail Greg Lampman 805-756-5182 or glampman@calpoly.edu 11-16

Wanted: Looking for a spare tire carrier for a Burma Jeep Cargo Truck. Please call Paul Lubker, (209)403-6261

SURPLUS CITY ★
JEEP PARTS

4514 Pacific Heights Rd. & Hwy 70
Oroville, CA 95965

Chuck Heindell ★
530-533-2500

1-800-353-3772 ★ www.surplusjeep.com ★ fax 530-534-6769

EMU, Inc.
Operators of EMU 309

Tony Lindsey
Public Relations
tony@hueyvets.com
(510) 468-9942



605 Middlefield Road
Redwood City, CA 94063
501(c)3 #20-0744013

www.HueyVets.com
Official website of EMU, Inc.



JAY'S WWII JEEPS

1-844-WW2-JEEP (992-5337)



Quality Parts, Knowledgeable Service

The search is over for reproduction parts for your vintage WWII Jeep. Built by Joe's Motor Pool in the United Kingdom, these high-quality parts were made with the utmost attention to detail, accuracy, and fit.

Order yours today from Jay's WWII Jeeps. We specialize in vintage WWII Willys MB and Ford GP & GPW vehicles and parts.



**"F" marked GPW
Bumper Bolts**
4 for \$15



U-Joints
4 for \$25



Brake Hose Set
\$27



**MB/GPW Safety
Door Anchors**
2 for \$20



MB/GPW Hub Caps
2 for \$12



**Tiger-Ey Reflector
with Bezel** | \$25



**MB/GPW Window
Chains** | 2 for \$7



**Window Screws, Chains
and Brackets Set** | \$22



Brown Cap and Rotor Set
\$12



Crossover Tube Clamp
2 for \$6

Coming in Early 2016

- Complete GP Tubs
- Slat Grill Footman Loops
- Combat Rim Bolts w/Nuts
- Steel-wound Speedometer Cables (MB/GPW/GP)
- Fuel Line Sets (MB/GPW)
- "F" Marked Head Bolts

CONTACT

Jay Hinton
Napa, California
1-844-WW2-JEEP (Toll Free)
Jay@jaysww2jeeps.com



The Foothills Vintage Jeep Group had 10 WW2 jeeps and one half-track that we filled with Veterans. The honoring theme this year was Our WW2 Veterans and all other Veterans that have served in our armed forces. We were also honored to be the Grand Marshal vehicle too. Once again a very large turnout for the parade route. Pictures supplied by Nancy Porter.

Great day!

Submitted by, Ben Hovis, FVJG Coordinator



Second M50A1 Ontos Restoration Completed, Marine Corps Mechanized Museum (CamPen) Bob Turley

Call about our 50 YEARS+ accumulation of NOS parts for jeep vehicles!

1-800-353-3772 ☎ 530-533-2500

SURPLUS CITY JEEP PARTS

Parts, Supplies & Technical Help for Military Vehicles & Civilian Jeeps for Over 48 Years

Military Paint Available
Military Specification Tops, Seats
and Strap Sets



Canvas by Vehicle

MB/GPW

Summer Top, A3216 - Summ.....	\$340.00
Front Seat Cushion Set, A3980-Set.....	\$99.00
Rear Seat Cushion Set, A2905-Set.....	\$104.50
Windshield Cover, A3211.....	\$125.00
Crash Pad Kit, A3114-K.....	\$24.50
Head Light Cover, A3070.....	\$27.50
Weather Cover, WCMB.....	\$217.75
Top Bow Strap Set, A3110-Set.....	\$17.50
Axe & Shovel Strap Set, A3139-Set.....	\$24.20
Fuel Can Strap, A4129-A.....	\$21.45
Top Storage Strap Set, A3141-Set.....	\$21.45

M38 & M38 A1

Winter Top, 674173, 680320.....	\$435.00
Front Cushion Set, 672000-Set.....	\$99.00
Rear Seat Cushion Set, 673497-Set.....	\$104.50
Weather Cover, WC-MB \$217.75, WC-M38A1.....	\$229.85
Side Curtain Set, 674197 Set, 680333 Set.....	\$180.00
Door Skins Set, 674972 Set.....	\$330.00
Axe & Shovel Strap Set, A3139 Set.....	\$24.50
Axe & Shovel Strap Set, 681275 Set.....	\$33.50
Top Bow & Windshield Strap Set, 672697 Set.....	\$33.00
Fuel Can Strap, A4127-B.....	\$21.45
Tailgate Chain Cover Set, 964835.....	\$15.00
Door Frame Set, 674970-Set, 680320-Set.....	\$300.00

M151

Canvas Top, 7345090.....	\$454.00
Front Cushion Set, 8754900-Set.....	\$145.00
Rear Seat Cushion Set, 7345140-Set.....	\$155.00
Weather Cover, WC-M38A1.....	\$229.85
Side Curtain Set, 11598910-Set.....	\$180.00
Door Skin Set, 7345100-Set.....	\$330.00
Pioneer Strap Set, 592636-Set.....	\$30.25

M715

Cab Top, 943739.....	\$375.00
Front Cushion Set, 945960-Kit.....	\$84.65
Pioneer Strap Set, 8690467-Set.....	\$30.25
Fuel Can Strap, A4127-B.....	\$21.45
Cargo Cover w/End Curtains, 11657158-Set.....	\$795.00
Tailgate Chain Cover Set, 964835.....	\$15.00

M422 & M422A1

Canvas Top, M422 or M422A1, 13287.....	\$585.00
Top N.O.S. Modified for M422A1, 13288.....	\$350.00
Front Seat Cushion, 3645-kit-RB.....	\$165.00

M35 & M36

Cab Top, 7372723.....	\$396.00
Fuel Can Strap Set, A4127-B.....	\$21.45

M37

Cab Top, 7707287.....	\$456.00
Fuel Can Strap, A4127-B.....	\$21.45
Cargo Cover w/End Curtains, 7707288-Set.....	\$795.00
Tailgate Chain Cover Set NOS, 7005441.....	\$15.00

**EXCITING
 NEW WEB SITE
 FOR ORIGINAL
 JEEP PARTS**

www.originalmilitaryjeeparts.com

Remanufactured Engines 3yr/36,000 Mile Warranty



M28/M29/M29C

Seat Cover Set, SD95443-Set.....	\$137.50
Cargo Cover, SD95440.....	\$181.50
Windshield Cover, SD954409.....	\$165.00

M100

Trailer Cover, A4048.....	\$138.00
---------------------------	----------

M416

Trailer Cover w/Tie downs, 10913205.....	\$138.00
--	----------

Radio Covers

BC610/BC659, BG-153.....	\$137.50
BC604, BG96.....	\$180.00
VRC3.18, CW330G.....	\$125.00

Civilian Models

CJ2A, 3A, 3B, Early CJ5

Front Cushion Set, 672000-Set.....	\$99.00
Rear Cushion Set, 673497-Set.....	\$104.50
Front Cushion Set, 672000-Set Vinyl.....	\$137.50
Rear Cushion Set, 673497-Set Vinyl.....	\$154.00
Weather Cover, WC-M38A1.....	\$229.85

Custom Fit Jeep Covers

Flat fender model fits MB/GPW, M38, CJ3A, WC MB.....	\$217.75
Round fender model fits M38A1, CJ4, M151, WC M38A1.....	\$229.85

Sewn in our canvas shop from Matrix car cover material. This fabric allows moisture to escape but rain beads and rolls off. The inside is soft and gentle on your paint job. Can be used outdoors as a weather cover or indoors as a dust cover. This cover is custom fit to the vehicle and features a stretch band in the lower hem to keep the wind from lifting it. Fits over spare tire and gas can. Two large grommets are installed for a security cable or tie down running under the vehicle. Easy for one person to put on or remove. Light gray color outside, white inside. A storage bag is included.

Remanufactured Engines

Surplus City Jeep Parts carries remanufactured 4 & 6 cylinder engines for military vehicles and civilian jeeps. We can rebuild your engine or order one from stock and exchange your core. Please call to discuss the details on this. Subject to availability.

THE FOLLOWING PRICES EXCLUDE CORE EXCHANGE
 L-Head #5497-RB..... \$2,550.00

Willys L head, Chain Drive Cam used in MB & GPW, GPW block exchange available.

www.surplusjeep.com



See our Web Site
 for more parts
 and vehicles

M38/CJ2A&CJ3A

L-head #802023-RB.....	\$2,450.00
F-head #808879-RB.....	\$2,450.00
Willys F head to accept T-90 bellhouse. Used in M38A1, CJ3, 38, 5, and 6.	
M151 4-cyl. #11680630-RB.....	\$2,250.00
M715 6-cyl. #943849-RB.....	\$3,100.00

Rebuilt Running Gear Components

Transmission Transfer, Steering Gear
 For: MB/GPW, M38, M38A1,
 CJ3A&B, Early CJ5

Carburetors * Fuel Pumps

MB/GPW, M38, M38A1, M422,
 M37, M274, M715

Starters * Distributors

Generators * Alternators

MB/GPW, M37, M38, M38A1,
 M151, M422, M274, M715
 Professionally Rebuilt *
 Core Exchange Required

Body Parts For

MB/GPW * M37 * M38 * M38A1
 M151 * M422 * M274 * M715
 Tubs, fenders, seats, frames, wind-
 shields, top bows, brackets, handles,
 brake parts, bumperettes, bumpers,
 gussets, wiring harnesses, emergency
 brakes

Tires For

MB/GPW * M37 * M38 * M38A1
 M151 Series * M422 * CJ2A * CJ3A
 CJ3B * CJ5 * CJ6 * CJ7 * M37 * M715

Military Specification Paint

Gallon \$45.00 ea.

Spray Can \$4.99 ea.

Call for available colors

Gallons & Spray Cans

CAL OSHO Compliant

Manuals For

MB/GPW * M37 * M38 * M38A1
 M151 Series * M422 * CJ2A * CJ3A
 CJ3B * CJ5 * CJ6 * CJ7 * M37 * M715

Surplus City Jeep Parts 4514 Pacific Heights Road, Oroville, CA 95965

Prices subject to change without notice. Please contact Surplus City Jeep Parts for current prices.

MVCC Membership Application, Membership is for the calendar year

Please print clearly

Name: _____ Address: _____

City: _____ State: _____ Zip: _____

Home phone: _____ Cell: _____

Email: _____ MVPA# (if applicable): _____

Membership Type Desired (check box)

\$35.00 Regular member \$60 Business (includes business card in newsletter). No voting rights.

\$85.00 three year discount Associate Members: \$5 each: spouse or significant other, and/or children under 18. Includes member card. badge add \$7.50 each. Spouse has voting rights.

One newsletter per household. \$25 Electronic membership

List Associates: NAME _____ RELATIONSHIP _____

NAME _____ RELATIONSHIP _____

Optional: List military vehicles you own, if any (year, make, model) and/or related hobby, For insertion into the membership Directory (Use a separate sheet if necessary)

I DO / DO NOT want my info in the Directory (circle one)

Mail application to: Christina Verissimo c/o MVCC Treasurer 850 Elm Avenue, Gustine CA 95322

Phone: (209) 918-0388 Email: crstna_vrsmo@yahoo.com Make Checks Payable to the MVCC

Military Vehicle Ownership is not Necessary to be a member of the MVCC

