

the

CALIFORNIA

MV

Collector

NEWSLETTER



EDITOR: DAVE BALL *

2018

* VOL. XLI, NUMBER 10



Front gate to the 49er RV Resort in Plymouth, CA. This venue and the adjoining Amador County Fairgrounds campground have been dubbed Camp Plymouth and are the new home of the Spring MVCC swapmeet starting April 2019. Lots of info in this newsletter to help you find a great place to camp, so that you can enjoy all the activities and buy and sell your Military Vehicle parts and accessories.

CONTENTS

UPCOMING EVENTS 3

MVCC STAFF 4, 5, 6, 7, 8, 9

CLASSIFIEDS 16, 17, 18

MVCC MEMBERSHIP APPLICATION 20

Brad Smardo
I Pay CASH For Military Items

Smardo-Militaria

No Item Too Small or Too Large Uniforms, Medals, Guns, Paperwork, Rifles
Cell (916) 521-6221 Patches, Helmets, Flags, Knives, Pictures
bsmardo@hotmail.com Field Gear, Pins, Badges, Hats, Swords, Caps



ANGUS SMITH
Vice President of the Board
Cell: (831) 240-5311
AngusJSmith@Frontier.com

GENERAL PATTON MEMORIAL MUSEUM

62510 CHIRIACO ROAD
CHIRIACO SUMMIT, CALIFORNIA 92201
www.GeneralPattonMuseum.com



"Where service comes first since 1926"

Smith Chevrolet Cadillac, Inc.

1601 Auto Mall Drive
Turlock, CA 95380



Lee C. Smith
Owner
(209) 632-3946
(209) 988-8832 Cell
(209) 667-7157 Fax
leesmith@SmithChevroletCadillac.com
smithchevroletcadillac.com



DOWNTOWN TRUCK PARTS

NORMAN GORELICK

20830 KINGSBURY ST
CHATSWORTH CA 91311

1-818-709-3676
MACK6X6@AOL.COM

MIDWEST MILITARY, INC.

www.midwestmil.com



PARTS & TRUCKS
BUY • SELL • TRADE • RESTORE
REPRODUCTION SHEETMETAL

JOHN BIZAL

Phone 952-440-8778 • Fax 952-440-8776
16075 Hwy. 13 South, Prior Lake, MN 55372

UPCOMING EVENTS

March 2019 Second Annual Southern California SCMVCC annual rally meet, military vehicle show / display, trail rides, club dinner, parts swap meet, and more... at Soledad Canyon Thousand Trails Campground in Acton.

Please contact Richard Johnson for reservations and info (619)993-5284 or killroy321@hotmail.com visit our website WWW.SCMVCC.com

April 23-28, 2019 49er village RV resort
No vendor or visitor fee except camping fee.
Free parking for day use.
More info to be announced soon.
Contact: Dave Ball 408-805-0065

September 2019: Camp Gridley
Butte County Fairgrounds, Hosted by the NRG
www.northernrecongroun.org

September 18-23, 2019 MVCC Fall swap-meet Second largest annual Military Vehicle gathering and swap meet in the West.
Location TBD
For reservations, please call Joann lesser 408-238-8277
www.mvccnews.net

November 3, 2018 Los Banos Veterans Day Parade. 11AM. Military Vehicles needed! POC is Don Gomes (209)765-1273 Last year we had 12 MV's. Display our MV's after the parade at the VFW Hall.

November 4, 2018 22nd Annual Tri-Valley Veterans Day Parade 2018 & Ceremony Parade Theme is "World War I 100th Anniversary"
POC: Andy Shyers 510-832-4322

November 4, 2018 Menlo Park VA Hospital will celebrate veterans day. 795 Willow Rd. Menlo Park, CA Cars Bikes and stars and stripes. For more info: Dave Johnston (408) 309-5064
Or Pete McFall pmcfall@prodigy.net

November 11, 2018 San Jose Veterans Parade
For more info and line up time POC: Kim Sievert
(408) 253-9469 vaudevillian@msn.com

November 11, 2018 2pm-6pm
Please join us following the City of San Jose Veterans Day Parade to celebrate our Veterans at Honor on The Row at Santana Row from 2-6 p.m. The event will feature a Gold Star Memorial to honor the fallen, a display of military vehicles and classic cars, a Care Package Collection Booth sponsored by The Cost of Courage Foundation and participation from several community and Veteran organizations including Blue Star Moms, Spirit of 45, Dignity Memorial, VSSA, the USS Hornet, Daughters of the American Revolution, the United Veterans Council and many more!
Bring the family and enjoy a day of honoring our heroes at Santana Row!
This event is free and open to the public.
POC: Kim Sievert
(408) 253-9469 vaudevillian@msn.com

November 11, 2018 Gustine Veterans Day Parade. 10AM. Military Vehicles needed! POC is Don Gomes (209)765-1273 Last year we had 4 MV's. Display our MV's at the VFW Hall after parade.

November 11, 2018 Turlock Veterans Charitable Trust Golf Tournament at Turlock Golf and Country Club. 8AM to 4PM. MV's needed for static displays. Last year we had 8 MV's. Food provided. POC is Lee Smith (209)988-8832

November 11, 2018 San Francisco Mayor's Salute to Veterans Parade. Start Time: 11:00a
Location: San Francisco, California - Fisherman's Wharf Area. San Francisco County Veterans organizations support and coordinate the Veterans Day Parade with support from the City of San Francisco.
POC Ray Pulver
Upbeat Parade Productions San Jose, CA 95123
408-629-2520www.upbeatparades.com

AT THE FRONT



Dave Ball, MVCC President
(408) 805-0065
vought@msn.com

Hello Everyone:

Hello Everyone....

I hope everyone had a great time at Tower Park last month. I had a great time, found some rare Jeep parts I have been hunting for and saw many more GI parts and accessories and some real bargains too. I hope everyone got to sell, buy and share what they found.

I want to thank everyone that brought parts to swap. I spent many hours going through them and found some great deals and a couple very hard to find new old stock parts. Best of times. As always it was good to see so many of you and to talk with you check out your vehicles and relax a little. I want to thank everyone that brought their vehicles. Lots of nice restorations getting done. Keep it going. Remember there are Jeep and Ford Burma displays happening this coming April of 2019. That's just 6 months away. :-)

I want to thank Damon Viola and Sean Nichols who have stepped up to be the POC for the Jeep showcase. These guys, as you know, are the stars of Jeep Talk. This April will be a great show so start getting ready now, so you can bring out your Jeep. Remember all Jeep vehicles from WW2 up to the M151 are welcome and any stage of restoration. If it rolls, bring it. We want to see it. The MVCC has many members and also many different types of vehicles. Those vehicles, whether freshly restored or original patina, are all welcome. I really enjoy seeing all the different vehicles including those with updated or custom work done to them. All military vehicles are welcome. No excuses - drive, tow or drag them to the swapmeets for all to enjoy your work.

We had a record turnout for the General Membership meeting Saturday morning with a couple hundred members present. I appreciate everyone that came to the meeting.

For those that were not able to attend the Fall swapmeet, the meeting discussion centered on the many changes that Tower Park has gone through. At the top of the list was the most recent rules changes, the poor treatment and service. My opening comment was that none of this matters now as the MVCC will not be returning to Tower Park.

That decision was not an easy one to make after so many years of MVCC events being held annually at Camp Delta. We all have fond memories of past events held there. Tower Park Resorts management has said no to groups. We tried to work with the local campground management team to keep our fall swapmeet there, but they could not work it out. Moving forward, look at the maps and articles and call Joann. We are on the move to Plymouth, CA.

“Keep 'em Rolling, Floating and Flying”

Dave Ball

President and Editor

Military Vehicle Collectors California

MVCC FRONT OFFICE



Christina Verissimo, Treasurer
(209) 918-0388
crstna_vrsmo@yahoo.com



John Verissimo, Secretary
(209) 918-0488
istanbull@sbcglobal.net

Secretary and Treasurer after action report September 2018 Tower Park Meet.

We arrived on Thursday, opened up the club merchandise trailer for business on Friday from 10AM to 12 NOON, then closed for lunch/board meeting, then opened up from 3PM to 6PM. Then opened up on Saturday after the membership meeting from 10:30AM to 5PM.

The Quarter Masters trailer had \$100 from the treasury for start up cash for change.

The following does not include start up cash:

The MVCC Quarter Masters sold \$430 in merchandise to members on Friday and \$1,000 on Saturday. The MVCC Secretary received 31 paid applications for memberships for a total of \$1,040 for both days.

This gives us a grand total of \$2,470 made on in two days at this event. Had we been open Thursday who knows what we could have made!? Lots of people came for the day on Thursday only.

Merchandise - we sold both old and new t-shirts, pennants, hats, sweaters, mugs, etc..

Dues - lots of new members and past members signed up due to the requirement you need to be a member to get a spot at Camp 49er early and with a club discount! Remember, dues money and merchandise money help the club help you. By supporting the club you are supporting the members so give yourself a pat on the back if you bought something!

One person commented that they had to get a membership because the MVCCNEWS.NET site changed their newsletter viewing of newsletters for non members, meaning you have to wait 6 months to view it on the public side if you are not a member so he went ahead and signed up for a membership so he could view it right off the press!

I've already processed and mailed out the new membership cards today!

As far as this meet went I consider it a success for its members, vendors, visitors and the MVCC personnel that help put it on. It was a good event, we had new members and old ones to join up. We got to meet new people and were able to help direct them to whom they wanted to see.

We hope everyone had a good time this weekend, we did! Thank you to everyone for coming by the booth and saying hi. Looking forward to seeing you all in April at CAMP PLYMOUTH!!!

Your secretary and treasurer,

Johnny & Christina~

MVCC STAFF



Don Gomes, Central Valley VP
Divisions 209,559,661,760
(209)765-1273
caddymanwestside@yahoo.com

HELLO MVCC MEMBERS!

I would like to say good day to all my MVCC members across the world! The days are getting shorter and the mornings colder.

Tower Park Fall Meet has come and gone, that was fast! It was great to see all the people in attendance at this event. Lots of old and new faces. Johnny Verissimo, Christina Verissimo and I manned the MVCC HQ Club Quartermasters Booth Friday and Saturday and made a decent profit for the club! We also signed up new members. Thanks for coming by and supporting your club.

I am working on the April 2019 Spring Meet GTB Burma Jeep and Bomb Truck Showcase so if you know of anyone with a Burma or Bomb truck please let me know and I will personally contact them to see if they would be willing to bring their vehicle to show in our showcase. I hope to make it a large showcase if possible. There will be plenty of room for transport trailers and free parking at the event so that will make things better for people hauling their MV's!

Well back to my restoration story of Froggy, my GTBS Ford Burma Jeep Bomb Service Truck. So after buying Froggy and having it delivered and accepting the delivery I pushed the Burma into my barn and started torching off all the excess metal off like safari cage and metal doors. Then next I had my son Jordan drive it to town to our local truck scales to have the truck weighted with the least weight that it could for the registration & Title procedure. Next we started removing the front bumper, rear bumper, front fenders, rear fenders, hood, windshield frame, windshield and wood bed. Next up, the DMV my favorite place in California to visit. The LONG process of getting Froggy registered began. Something interesting I had was the original pink slip from 1948 when the first owner bought it at the government auction, that was kinda neat. After getting FROGGY all stripped down I pulled a better set of front fenders from one of my other GTBS's that were in better shape and rust free. The next was to gather up all the sheet metal for the sand blaster. After the blasting was done I picked up all the parts and started the body work. I started metal finishing the small dents, welded holes and straightened up the rear single wheel fenders that are the rarest WW2 truck fenders you will ever find. One of the fenders was pretty rough so I had to learn how to use an English Wheel to get the ripples and bad dents out. I always like to do all my body work with some small imperfection to add character. Stay Tuned for my next installment.

Keeping History Alive

Don Gomes Central Valley V.P



Kim Sievert, South Bay VP
(408) 253-9469
vaudevillian@msn.com
Divisions 408, 669 North 650



Sonny Hanson, No. Bay, East VP
(707) 552-6918 Div. 707,415
sonnyhanson@comcast.net



Jack Valenti, Central Coast VP
 Divisions 831, 805 408 south
 LRDG@PRODIGY.NET
 831-595-3487

Well as we enter the final stretch of 2018, there doesn't seem to be much on the horizon for upcoming events (that I know of). If I'm wrong and you know of an event in the Central Coast area, please let me know.

The only local event that I am aware of is the Salinas Veteran's Day Parade. The promoters should be calling me shortly to see if any of us will be attending. So if you are at all interested let me know so I can pass on that information.

For myself (and the LRDG jeep) I plan to be in San Jose at Santa Row for a static display on the Nov. 11th with T-8 and Doug Boales and his crew of volunteers for the day.

Donna and I had an interesting trip during Aug/Sept. My grandson's wedding went off without a hitch overlooking a beautiful lake in Connecticut on Aug 31st. We were there for a few days then left for the Baltic Cruise. The cruise ship got stuck in St. Petersburg an extra night when the Port authorities closed it for bad weather (40 knot winds). So we missed our next port of call. Other than that; the weather was cooler than we expected, we managed to overcome that by buying some sweater with a "Nordic" design.

Now that I think of it there may be some local Christmas events, if I hear of any I'll contact my local group and pass on the information.

Jack



Scott Rohrs, North. Bay West VP
 Divisions 707 & 415 west
 415-259-8177
 recon3rdid@yahoo.com



Dave Porter, Northern Region VP
 Divisions 530 & 916
 dnporter56@comcast.net
 530-677-5115



MVCC NEWS STAFF



MVCC Editor Dave Ball
 (408) 805-0065 vought@msn.com
 Please submit all contributions for the newsletter
 by email to the editor by the 15 of the month.



Webmaster Sean Nichols
Jetnoise400@hotmail.com
www.mvccnews.net
 (775)-424-3813

If you have any questions or have information regarding a meet or activity in your area, contact your regional vice president or any of the officers to let them know. Be sure to visit our website for any last minute activities or changes to activities/events. Please submit information regarding upcoming activities to the newsletter editor at least two months before the scheduled event. All articles must be submitted to the newsletter editor by the 15th of each month.

MVCC News Editor Dave Ball vought@msn.com

www.mvccnews.net

IMPORTANT NEWS!
WAGON MISTRESS REPORT

Jo-Ann Lesser

Hang on to your hats folks, it's gonna be another crazy ride! The MVCC is moving our April 2019 encampment and swap to the **49er Village RV Resort, 18265n Hwy 49, Plymouth, CA. April 14-20, 2019.** Jellystone didn't appreciate how wonderful we were and kicked us to the curb....again!

To be pre-registered for a site please send name, phone number, MVCC member number, type of site needed as well as length of RV, truck/trailer and number of nights staying to MVCCcampmistress@yahoo.com. A reply e-mail will provide site number assigned and how and when to make a deposit to the 49er.

There have been some questions as to what constitutes an RV. An RV is a vehicle or trailer that is or has been designed with living spaces. Examples: motor home, camper van, 5th wheel, truck camper, travel trailer, toy-hauler. The contract that was signed with the 49er states, **“no tents, no sleeping in utility trailer, no sleeping in trailers or trucks with canvas top.”** If you were assigned a site and plan on camping in your utility trailer, pick-up truck bed or deuce.....Don't! This is our first time at this resort and we don't want your action to reflect badly on the MVCC. Please contact me at the above e-mail address so that we can work together to find the best site for you.

49er rates for our event are as follows with a 4 night minimum. Rally rates are available from April 13 to April 24, 2019. A one night deposit will hold your site with payment in full upon check in. At this time there are no cottages available. However, I will be keeping a wait list in case of any cancellations.

1&2 bedroom cottage \$217./night includes tax

Studio cottage \$147./night includes tax

waterfront (WF) premium site average at \$59./night

standard/premium sites average \$48.50/night

check in 1pm \$20. early check in fee

check out 12pm \$20. late check out

The Amador County Fairgrounds will be the area for tenting. It backs up to the 49er Resort and there is a walk through gate from the fairgrounds to the 49er. The fairgrounds will provide limited water/electric sites as well as dry camping sites. At this time there are no water/electric sites available. I will be keeping a wait list for water/electric sites in case of cancellation. Registration for tent camping can be made through me at MVCCcampmistress@yahoo.com. A reply e-mail will explain how and when to make payment. Rates are as follows with no minimum stay.

Dry tent \$25./night

Water/Electric \$35./night (Bring extension cord)

There is no shade at the fairgrounds nor picnic tables, please place accordingly.

Payment for tenting needs to be paid in full prior to check in at the fairgrounds. Simply multiply the rate by the number of nights staying and send a check to the MVCC Treasurer. MVCC will then write one check to cover cost of tenting to the fairground.

All guest, visitor and dropped trailer parking will be at the fairground at no charge.

I will do my best to reply to e-mail on a daily basis. If you need to speak with me about a concern or question I will be available after 1pm weekdays at 408.238.8277 or 408.440.6068



Andy Shyers East Bay VP
Divisions 510, 925
510-832-4322
mvcc510925@gmail.com

Hello 510/925 MV'ers,

keep the two upcoming events in mind. There's the **Tri-Valley Veterans Day Parade on 11/4** and the **SF Mayor's Veterans Day Parade on 11/11**. We're attending both events. **If you're planning on attending please contact me so I can get a vehicle count.**

On an unrelated note, we have the 1952 Clarktor 6 up and running. (picture below) I've never had so much fun in something so slow. After cleaning off decades of mud, crud, and mystery gunk the kids and I were able to free up the motor, get the electricals sorted, and after a bit of futzing around it fired up! I can't believe it will run on the funky gas in it, but it does. The cast iron rear fenders were replaced with "lightweight" models so this thing will accelerate hard...to 14mph!

Hope to see you soon

Andy
510-832-4322



CAMP PLYMOUTH



The above map shows the 49er RV Park layout which offers RV and cabin camping and shares a fence and walking path with the Amador County Fairgrounds. At the fairgrounds, we have lots of space for displays and free parking for day visitors and tow vehicles and trailers. They also offer very reasonably priced tent camping. There is a map of the fairgrounds with the site layout on Page 11.

**AMADOR FAIRGROUNDS
MVCC TENT CAMPING & PARKING**

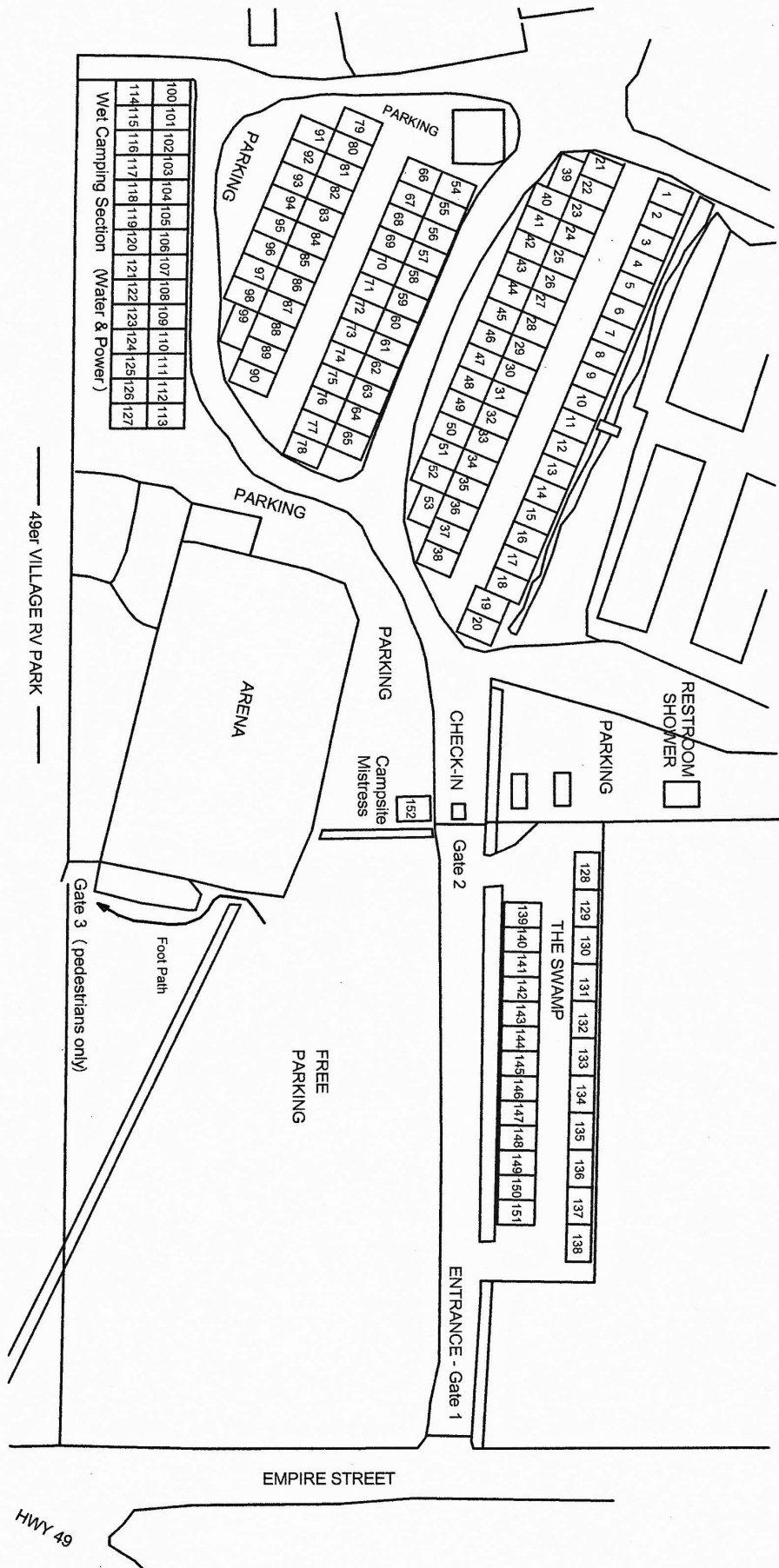



Top left: and right: Dodge "Shop Truck" Middle left: Vehicles at the display on Friday afternoon bottom left: Dean Peck and his Jeep bottom right Mark Jones and his Firetruck. Pictures taken at Fall Tower Park 2018. ED.



Top: Glen Closson's Hummer Bottom: M38A1 very nicely restored

ED.

MVCC BUSINESS MEMBERS



Department of California
DAV
Established 1921

ANDREW MOJARRAS
JR. VICE COMMANDER
2017-2018

P.O. Box 1872
TURLOCK, CA 95380

(209) 712-8572
andrewcadav@gmail.com
www.davcal.org

FULFILLING OUR PROMISES
TO THE MEN AND WOMEN WHO SERVED

Dc Truck parts 541-772-8992

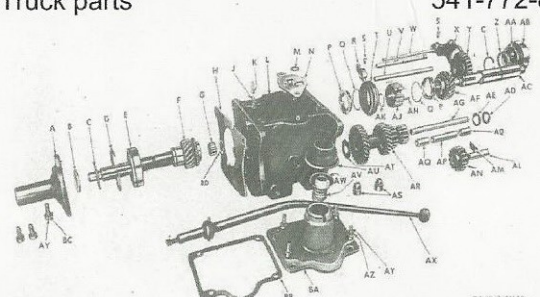

Dave Cirillo
dctruckparts@msn.com

EXPEDITION IMPORTS
Get Out of the Ordinary!

Scott Ingham
President

scott@expedition-imports.com
www.mpttires.com
www.expedition-imports.com

1335 Lemon Street
Vallejo, CA 94590
Tel 707.643.6757
Cell 707.319.7252
Fax 707.643.2998

Ray Del Pino  **DMV License #VV17807**

ANTIQUE • CLASSIC • MODERN
VIN NUMBER VERIFICATION
AT YOUR LOCATION IN SOUTHERN CA
TRUCKS, TRAILERS, SPECIAL MOBILE EQUIPMENT
MOTOR HOMES, AND CARS
DMV RUNNER SERVICE
CLASS C DRIVEAWAY - GETAWAY DRIVER
15708 E. Grovecenter St. • Covina, CA 91722
Cell: (626) 391-2167 • Home: (626) 814-2196

JAY'S
WWII JEEPS

Specializing in vintage
WWII Willys MB/Ford GPW
vehicles and parts

1-844-WW2-JEEP



Jay Hinton | Napa, California USA | 1-844-992-5337 | jay@jaysww2jeeps.com



CARSON PLAINS SURPLUS & STORAGE
Military Surplus, Military Vehicles, Storage, Firewood
JON BIRCHEFF
Owner



P.O. Box 1289
70 S. Rainbow Dr
Dayton, NV 89403
Cell: 775-246-7186
Fax: 775-241-7142
jon.cpsands@gmail.com
www.cpsands.com

Military Vehicle Collectors of California Merchandise



2018 MVCC Camp Petaluma Tshirt. This year we chose a Vietnam Era Theme.

This is a limited Run MVCC Event TShirt.

Sizes: S, M, L, XL - \$20 each
Sizes: XXL, XXXL - \$22 each

Zip Up Hoodie Sweaters, ONLY 18 made.

Sizes: S, M, L, XL - \$55 each
Sizes: XXL, XXXL - \$60 each

Limited quantities, get yours while they are still available!



40th Anniversary MVCC 4 inch Patch.
 \$6.00 each



25th Anniversary MVCC 4 inch Patch.
 \$4.00 each

Custom MVCC Name Badge \$10 each shipped to you.



MVCC Patch 3 1/2 inch
 \$3.00 each



MVCC Magnate 3 inch
 \$2.00 each

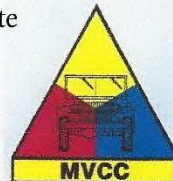

MVCC Sticker 3 inch
 \$2.00 each

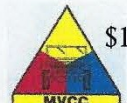

MVCC Sticker 2 inch
 \$1.00



MVCC Antenna Flag.
 Custom made.
 \$25 each



MVCC Hat
 NEW!
 \$20 each

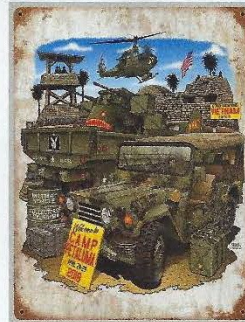

2018 Camp Petaluma Art Work Metal Sign
 11.5x14.5 size
 \$25 each

How to purchase: You can email or call your order to Johnny Verissimo, istanbull@sbcglobal or (209)918-0488. I'll let you know if its in stock and give you a shipping quote.

How to pay: Check or Money order. The club is working on getting a paypal account but its not finished yet.

Shipping: Average shipping is \$7.99 but if its a really small order it can be less or if its a large order or out of country it might be more so get a quote from me before sending payment.

Camp Petaluma: All the above will be for sale at Camp Petaluma (April) and Camp Delta (September).

CLASSIFIEDS

FOR SALE: 1952 Willys M38A1 Jeep has many of the original parts. Seats front and rear need pads and canvas. Still 24 Volt. Engine ran a year ago but rough. Missing top bows and batteries. \$3000 OBO.

Dave 408-805-0065 10-18

FOR SALE: M101-A1 TRAILER, CARGO 3/4 TON with Cover and Racks. Like new tires and spare tire. Small amount of rust in front of trailer. All Military, 24V \$900.00

ARCTIC TOP for 151/151A1/151A2 New Old Stock, in wood box. \$500.00

Call Ace Clark if interested.

775-972-8742 Located in Reno, NV

10-18

FOR SALE: Custom full size replica M1A1, 75mm Pack Howitzer with 12 gauge shotgun breach for firing blank black powder shells. This replica Howitzer is not able to fire any live ammunition.

This replica Howitzer will turn heads during a parade or other military celebrations. I had this Howitzer built from a base unit I purchased some years ago.

This unit includes platform, cannon, original 75 mm Pack Howitzer wheels and hubs Some photo of cannon was taken with M151 style wheels but the cannon now has

correct wheels. This cannon is a 100% replica with exception of the hubs, wheels and a few other small parts. Asking \$14,500 OBO. More info and pictures 541-914-2917 email nuksub612@comcast.net 10-18

FOR SALE: WWII GMC & Chevrolet Parts:

Re-cored radiator - never installed \$750. Useable wheels (with bad tires), \$40. each. Rear axle shafts, \$80. each, front fenders, drivelines, other misc.

Located in Geyserville, CA.

Richard Privat 707-484-8257

Email: rpironman@hotmail.com 11-18

FOR SALE: 1945 Willys MB. Europe return Complete teardown and restoration. Using all original parts and hardware. Has under hood lube chart and holder, grease gun, tire pump. 2018 canvas top and half doors. G.I. tow bar installed includes standard bumper and wood insert. Includes restored MBT trailer with a 2018 canvas cover. For more info call Ernestine Chambers 530-846-4218 10-18

WANTED: US WWII Small Wall Tent in good condition. John at 415-847-2801 or in_garage@hotmail.com 11-18

FOR SALE AND RESTORATION:

1) 1943 Ford GPW - most of it is there - will run but smokes - frame off restoration done 40 years ago -

extra GPW engine goes with sale- title-- \$ 8500,00

2) 1945 Ford GPW - complete running gear - body tub, hood, fenders etc., grill, windshield frame & inner, 2 combat wheels, MB engine title. \$ 2900.00

3) 1942 Ford Script complete running gear, hood, body tub, fenders, MB engine etc. no title \$ 2800.00

4) 1945 Willys MB - complete running gear, hood fenders, body tub repair or replace, windshield & inner - title \$ 2500.00

I would prefer to sell as one lot but flexible.

Contact John @ tidyacres@hotmail.com

(510) 821-0355 10-18

FOR SALE: 1944 Ford M20 Armored Utility Car.

This has been to our meets for a number of years. Street driven to 50 mph. Current CA registration. No brake issues, powerful. Many spares. Time to move on. \$73,000. Consider WWII jeep as partial trade. No show jeeps or real nice ones. Or partial trade for 28 -30 foot flatbed trailer. Own the dream.

John at 415-847-2801 or in_garage@hotmail.com.

11-18

Classified Ads are free for military vehicle related items and kit for MVCC members. Your ad will run for three issues. Your editor will only except ads in writing. Please submit your ad by email: vought@msn.com or by post to: MVCC Editor: 18549 Paseo Tierra St. Saratoga Ca. 95070. Please print clearly and include contact info and price. Please submit ads by the 15th of the month. If you want to make changes to your ad including extending or cancelling your ad, you must notify your editor in writing. The MVCC is not responsible for omission's or Incorrect wording and or spelling. The MVCC reserves the right to edit ad copy for space. Please send payment for paid ads to: LK Viola, Email: sec-treasurer@mvcnews.net

Ad prices: full page \$45 Half page \$35 Quarter Page \$20 Business Card \$5 per issue

CLASSIFIEDS

FOR SALE – Beautiful 1968 M151-A1 Jeep (Mutt) for sale in excellent condition. This Mutt is real clean, no rust and has been restored to run dependably for parades, road trips and every day driving. It has a legal Oregon title. new canvas roof and all seat cushions, new wiring harness from Wiring Harness of Maine (front harness installed), complete set of manuals, gauges, lights and re-built and functioning heater/defroster. This jeep comes with tons of spare parts:

Asking \$14,500 OBO. Contact: 541-914-2917
email nuksub612@comcast.net 10-18

FOR SALE: 1953 M38A1 USMC Jeep Willys Registered on a NON OP Radio RT68 NOS with mount and antenna 5 new rims and tires Recent minor body work and paint. Professionally relined gas tank, re-built generator, radiator, new clutch and resurfaced fly wheel, new break pads, Have photos before the breakdown and after. One complete Jeep and Enough other parts for almost another complete Jeep Includes: 1964 M416 Trailer. \$10,000. Jeep Trailer 1,500.00

For Sale: 1952 Dodge M43 Registered Historical plates \$4000.00 Raquel Lantz Rainwater Kern County 661-972-2742 11-18

FOR SALE: 1943 Ford GTBS Bomb Service Truck Excellent Condition With 6 Bombs Fully Restored Complete Canvas \$25,000

For Sale: 1968 M274A5 ½ Ton 4X4 Platform Vehicle By Baifield All options with 4-rear seats and 50 Cal. Mount Excellent runner. Fording Kit \$22,500

For Sale: 1942 Dodge ¾ Ton WC 56 Command Car Patton Special with air Horn and siren Solid older restoration Top is worn. With 50 Cal Mount (No Gun) \$25,000

For Sale: 1951 Willys M-38 Older Restoration with Gun Mount Great condition with winch & new Batteries \$20,000

For Sale: 1947 US Army Signal Corps ¼ Ton K-38 Telephone Cable Splicing Trailer (Highway Trailer Company) New tires unrestored Good condition \$1,000 **Brad 818 419-9989**

www.americanmovietrucks.com 11-18

FOR SALE: 1942 Dodge WC24 1/2 ton Command Car with winch. Kind of bare bones but has the winch, engine and good sheet metal. \$4300. More pictures can be emailed. Lee. Picture below whenlde@aol.com 925-447-9387. 11-18

FOR SALE: M100 Trailer rough great for hauling parts to swap meets. \$450obo, Ben Hur wooden side rack with all metal brackets wood rough good for patterns . \$180obo WW2 antenna mount square swinging type . \$150obo Ford GTB battery box great condition . \$150 . 2 G506 or M6 , CCKW Chevy 20in rims blasted& primed \$250 obo . 1 M5 Bomb trailer rough condition parts maybe restore \$450 obo Also will trade for WW2 Bomb Ordnance equipment. Call or text Don 209-765-1273 12-18

FOR SALE: cleaning out two major estates, lots of items coming up. This month for sale items are misc. military tents, poles and canvas, various prices. Also a complete (less sight) M63 50cal ground mount for \$1350 and a complete heavy duty military truck tow bar setup for \$350. A fairly nice Bantam trailer that I am posting for a friend, \$1800 obo. Hundreds of other items coming up, mostly web gear, uniforms, naval items, and who knows what.

Lee Edwards 925-447-9387 whenlde@aol.com
Pictures below. 12=18



CLASSIFIEDS

FOR SALE: M-416, 1/4 ton trailer, Frame off sand blasted, all new electrical harnesses, new chain hooks, new lights, freshly painted Army green, New data plates, new drain plugs, Looks great!!! \$2300.00
Top picture below left

FOR SALE: M-416, 1/4 ton trailer, perfect condition, rare top original military, every thing original, has 24 volt tail lights, and 12 volt lights. Absolute perfect. \$3200.00 firm.

Bottom picture below left

12-18

Brad Carrott
831 345-0372



FOR SALE: 1942 Chevy 1 1/2 ton G7116
Lots of work has been done to bring this Chevy back to its former glory, it runs, drives and stops like a champ. All the canvas is new and new tires all round. This truck is ready for the next parade. \$15,000 or best offer.

Contact Darren Marshall 650 417 8813

See 3 pictures below right

11-18



11 NOVEMBER 2018

VETERANS DAY

*Honoring all who
Served.*

VETERANS DAY PARADE
 SUNDAY, NOVEMBER 11, 2018, 12 P.M.
 BOB HART SQUARE - DOWNTOWN MERCED
 REMEMBERING OUR WWI VETERANS - 100 YEARS

SMITH CHEVROLET CADILLAC
 7th Annual
 Honoring Our Veterans Golf Tournament
 BENEFITTING THE
TURLOCK VETERANS CHARITABLE TRUST
 Monday, November 12th, 2018 at Turlock Golf & Country Club
TOURNAMENT SPONSOR PACKAGES

Turlock Veterans Charitable Trust
 is a 501(c)3 non-profit organization. A portion
 of your donation may be tax deductible.
 Please consult your tax advisor.
 Tax ID number: 47-5076858

******* GENERAL \$5000**

- Includes two, 4-somes in tournament
- Logo in all signage for the tournament,
- "Outstanding Sponsor Banner",
- Logo in all golf carts as a ***** sponsor
- Hole flag sponsor (Min. 6)
- Outstanding sponsor plaque

****** LT. GENERAL \$3500**

- Includes 4-some in the tournament
- Logo on our "Outstanding Sponsor Banner"
- Logo in all golf carts as a *** sponsor
- Outstanding sponsor plaque

***** MAJOR GEN. \$2000**

- Includes a 4-some in the tournament
- Logo on our "Outstanding Sponsor Banner"
- Outstanding sponsor plaque

*** BRIGADIER GEN. \$150**

- Your logo on an 18x24 commemorative wooden plaque displayed at a Tee-Box

Call for Info: (209) 613-7352
 Make checks payable to:
 "Turlock Veterans Charitable Trust"
 2930 Geer Rd. #154, Turlock CA 95382

Turlock Country Club
 10552 Golf Link Rd - Turlock, CA

TURLOCK GOLF & COUNTRY CLUB
 ESTABLISHED 1924



Military Vehicle Collectors of California
*Dedicated to the acquisition, restoration, preservation, safe operation,
 Public education and display of historic military transport*

WE WANT YOU
TO JOIN / RENEW
YOUR
MVCC
MEMBERSHIP!



INVOICE

Life Members should disregard this notice. THANK YOU for your support! If you have already renewed, THANK YOU! please check the date code on your newsletter mailing label and membership card. Is your expiration year "2017" ?

If it is this means your membership expires January 1, 2017. Please renew your membership.

Please enter an e-mail address for possible future methods of communication. If you list MV's or related hobby interest, it will show up on membership lists the MVCC Officers receive. Sometimes we want to contact members with certain MV's about displays or movie work. Note that you may opt-out of having contact or hobby information published in the next Member Directory booklet. This is your application. Separate it from the newsletter, or copy it, fill it out, and fold it put it in an envelope with your check inside, apply postage, and mail it. Simple!

* = required fields, please PRINT

*Name _____ MVPA # if applicable _____

*Address 1 _____

Address 2 _____

*City, State, ZIP _____ Country _____

Home phone _____ Cell phone _____

E-mail address _____

I DO / DO NOT want my contact information in the Directory (circle one)

List military vehicles you own (year, make, model) and/or related hobby for the next Directory. Help those with similar interests find you. Use separate sheet if necessary.

MEMBERSHIP (check one)

Term is Jan 1 – Dec 31

- \$35 regular member for one year only newsletter mailed
- \$85 regular member for three years newsletter mailed
- \$25 regular member for one year only newsletter online only
- \$60 regular member for three years newsletter online only
- \$60 business member (includes one, 2"x 3.5" ad in each newsletter (business card). No voting rights. A business member may also hold another class of membership

ASSOCIATE MEMBERS (spouse or significant other, and/or children under 18).

Includes membership card. Only spouse has voting rights.

One newsletter delivered per household

_____ Associates @ \$5.00 each per year, badge \$12.50

New members receive one badge. Associate Badges and replacement badges \$12.50 ea.

Amount enclosed _____

Print associate name and relationship to member

Christina Verissimo, c/o MVCC Treasurer,
 850 Elm Street Gustine, Ca 95322
 Make checks payable to the MVCC

*I DO / DO NOT want my MVs or hobby interests listed in the next Directory (circle one)